

# LM35/LM35A/LM35C/LM35CA/LM35D

## Precision Centigrade Temperature Sensors

### General Description

The LM35 series are precision integrated-circuit temperature sensors, whose output voltage is linearly proportional to the Celsius (Centigrade) temperature. The LM35 thus has an advantage over linear temperature sensors calibrated in ° Kelvin, as the user is not required to subtract a large constant voltage from its output to obtain convenient Centigrade scaling. The LM35 does not require any external calibration or trimming to provide typical accuracies of  $\pm 1/4^\circ\text{C}$  at room temperature and  $\pm 3/4^\circ\text{C}$  over a full  $-55$  to  $+150^\circ\text{C}$  temperature range. Low cost is assured by trimming and calibration at the wafer level. The LM35's low output impedance, linear output, and precise inherent calibration make interfacing to readout or control circuitry especially easy. It can be used with single power supplies, or with plus and minus supplies. As it draws only  $60\ \mu\text{A}$  from its supply, it has very low self-heating, less than  $0.1^\circ\text{C}$  in still air. The LM35 is rated to operate over a  $-55^\circ$  to  $+150^\circ\text{C}$  temperature range, while the LM35C is rated for a  $-40^\circ$  to  $+110^\circ\text{C}$  range ( $-10^\circ$  with improved accuracy). The LM35 series is

available packaged in hermetic TO-46 transistor packages, while the LM35C, LM35CA, and LM35D are also available in the plastic TO-92 transistor package. The LM35D is also available in an 8-lead surface mount small outline package and a plastic TO-202 package.

### Features

- Calibrated directly in ° Celsius (Centigrade)
- Linear + 10.0 mV/°C scale factor
- 0.5°C accuracy guaranteeable (at +25°C)
- Rated for full  $-55^\circ$  to  $+150^\circ\text{C}$  range
- Suitable for remote applications
- Low cost due to wafer-level trimming
- Operates from 4 to 30 volts
- Less than  $60\ \mu\text{A}$  current drain
- Low self-heating,  $0.08^\circ\text{C}$  in still air
- Nonlinearity only  $\pm 1/4^\circ\text{C}$  typical
- Low impedance output,  $0.1\ \Omega$  for 1 mA load

**LM35/LM35A/LM35C/LM35CA/LM35D**  
**Precision Centigrade Temperature Sensors**

### Connection Diagrams

**TO-46**  
**Metal Can Package\***

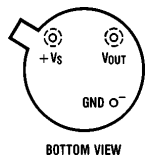

TL/H/5516-1

**TO-92**  
**Plastic Package**

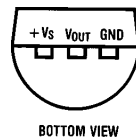

TL/H/5516-2

**SO-8**  
**Small Outline Molded Package**

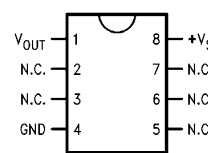

TL/H/5516-2

\*Case is connected to negative pin (GND)

**Order Number LM35H, LM35AH, LM35CH, LM35CAH or LM35DH**  
**See NS Package Number H03H**

**Order Number LM35CZ, LM35CAZ or LM35DZ**  
**See NS Package Number Z03A**

**Top View**  
N.C. = No Connection

**Order Number LM35DM**  
**See NS Package Number M08A**

**TO-202**  
**Plastic Package**

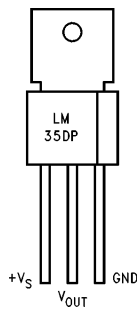

TL/H/5516-24

**Order Number LM35DP**  
**See NS Package Number P03A**

### Typical Applications

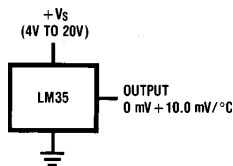

TL/H/5516-3

**FIGURE 1. Basic Centigrade Temperature Sensor (+2°C to +150°C)**

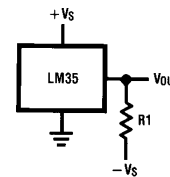

TL/H/5516-4

Choose  $R_1 = -V_S/50\ \mu\text{A}$

$V_{OUT} = +1,500\ \text{mV at } +150^\circ\text{C}$   
 $= +250\ \text{mV at } +25^\circ\text{C}$   
 $= -550\ \text{mV at } -55^\circ\text{C}$

**FIGURE 2. Full-Range Centigrade Temperature Sensor**

TRI-STATE® is a registered trademark of National Semiconductor Corporation.

## Absolute Maximum Ratings (Note 10)

If Military/Aerospace specified devices are required, please contact the National Semiconductor Sales Office/Distributors for availability and specifications.

Supply Voltage	+35V to -0.2V
Output Voltage	+6V to -1.0V
Output Current	10 mA
Storage Temp., TO-46 Package,	-60°C to +180°C
TO-92 Package,	-60°C to +150°C
SO-8 Package,	-65°C to +150°C
TO-202 Package,	-65°C to +150°C

Lead Temp.:

TO-46 Package, (Soldering, 10 seconds)	300°C
TO-92 Package, (Soldering, 10 seconds)	260°C
TO-202 Package, (Soldering, 10 seconds)	+230°C

SO Package (Note 12):

Vapor Phase (60 seconds)	215°C
Infrared (15 seconds)	220°C

ESD Susceptibility (Note 11) 2500V

Specified Operating Temperature Range:  $T_{MIN}$  to  $T_{MAX}$

(Note 2)

LM35, LM35A	-55°C to +150°C
LM35C, LM35CA	-40°C to +110°C
LM35D	0°C to +100°C

## Electrical Characteristics (Note 1) (Note 6)

Parameter	Conditions	LM35A			LM35CA			Units (Max.)
		Typical	Tested Limit (Note 4)	Design Limit (Note 5)	Typical	Tested Limit (Note 4)	Design Limit (Note 5)	
Accuracy (Note 7)	$T_A = +25^\circ\text{C}$	$\pm 0.2$	$\pm 0.5$		$\pm 0.2$	$\pm 0.5$		°C
	$T_A = -10^\circ\text{C}$	$\pm 0.3$			$\pm 0.3$		$\pm 1.0$	°C
	$T_A = T_{MAX}$	$\pm 0.4$	$\pm 1.0$		$\pm 0.4$	$\pm 1.0$		°C
	$T_A = T_{MIN}$	$\pm 0.4$	$\pm 1.0$		$\pm 0.4$		$\pm 1.5$	°C
Nonlinearity (Note 8)	$T_{MIN} \leq T_A \leq T_{MAX}$	$\pm 0.18$		$\pm 0.35$	$\pm 0.15$		$\pm 0.3$	°C
Sensor Gain (Average Slope)	$T_{MIN} \leq T_A \leq T_{MAX}$	+10.0	+9.9, +10.1		+10.0		+9.9, +10.1	mV/°C
Load Regulation (Note 3) $0 \leq I_L \leq 1 \text{ mA}$	$T_A = +25^\circ\text{C}$	$\pm 0.4$	$\pm 1.0$		$\pm 0.4$	$\pm 1.0$		mV/mA
	$T_{MIN} \leq T_A \leq T_{MAX}$	$\pm 0.5$		$\pm 3.0$	$\pm 0.5$		$\pm 3.0$	mV/mA
Line Regulation (Note 3)	$T_A = +25^\circ\text{C}$	$\pm 0.01$	$\pm 0.05$		$\pm 0.01$	$\pm 0.05$		mV/V
	$4\text{V} \leq V_S \leq 30\text{V}$	$\pm 0.02$		$\pm 0.1$	$\pm 0.02$		$\pm 0.1$	mV/V
Quiescent Current (Note 9)	$V_S = +5\text{V}, +25^\circ\text{C}$	56	67		56	67		$\mu\text{A}$
	$V_S = +5\text{V}$	<b>105</b>		<b>131</b>	<b>91</b>		<b>114</b>	$\mu\text{A}$
	$V_S = +30\text{V}, +25^\circ\text{C}$	56.2	68		56.2	68		$\mu\text{A}$
	$V_S = +30\text{V}$	<b>105.5</b>		<b>133</b>	<b>91.5</b>		<b>116</b>	$\mu\text{A}$
Change of Quiescent Current (Note 3)	$4\text{V} \leq V_S \leq 30\text{V}, +25^\circ\text{C}$	0.2	1.0		0.2	1.0		$\mu\text{A}$
	$4\text{V} \leq V_S \leq 30\text{V}$	<b>0.5</b>		<b>2.0</b>	<b>0.5</b>		<b>2.0</b>	$\mu\text{A}$
Temperature Coefficient of Quiescent Current		+0.39		+0.5	+0.39		+0.5	$\mu\text{A}/^\circ\text{C}$
Minimum Temperature for Rated Accuracy	In circuit of Figure 1, $I_L = 0$	+1.5		+2.0	+1.5		+2.0	°C
Long Term Stability	$T_J = T_{MAX}$ , for 1000 hours	$\pm 0.08$			$\pm 0.08$			°C

**Note 1:** Unless otherwise noted, these specifications apply:  $-55^\circ\text{C} \leq T_J \leq +150^\circ\text{C}$  for the LM35 and LM35A;  $-40^\circ\text{C} \leq T_J \leq +110^\circ\text{C}$  for the LM35C and LM35CA; and  $0^\circ\text{C} \leq T_J \leq +100^\circ\text{C}$  for the LM35D.  $V_S = +5\text{Vdc}$  and  $I_{LOAD} = 50 \mu\text{A}$ , in the circuit of Figure 2. These specifications also apply from  $+2^\circ\text{C}$  to  $T_{MAX}$  in the circuit of Figure 1. Specifications in **boldface** apply over the full rated temperature range.

**Note 2:** Thermal resistance of the TO-46 package is  $400^\circ\text{C}/\text{W}$ , junction to ambient, and  $24^\circ\text{C}/\text{W}$  junction to case. Thermal resistance of the TO-92 package is  $180^\circ\text{C}/\text{W}$  junction to ambient. Thermal resistance of the small outline molded package is  $220^\circ\text{C}/\text{W}$  junction to ambient. Thermal resistance of the TO-202 package is  $85^\circ\text{C}/\text{W}$  junction to ambient. For additional thermal resistance information see table in the Applications section.

## Electrical Characteristics (Note 1) (Note 6) (Continued)

Parameter	Conditions	LM35			LM35C, LM35D			Units (Max.)
		Typical	Tested Limit (Note 4)	Design Limit (Note 5)	Typical	Tested Limit (Note 4)	Design Limit (Note 5)	
Accuracy, LM35, LM35C (Note 7)	$T_A = +25^\circ\text{C}$	$\pm 0.4$	$\pm 1.0$		$\pm 0.4$	$\pm 1.0$	$\pm 1.5$	$^\circ\text{C}$
	$T_A = -10^\circ\text{C}$	$\pm 0.5$			$\pm 0.5$		$\pm 1.5$	$^\circ\text{C}$
	$T_A = T_{\text{MAX}}$	$\pm 0.8$	$\pm 1.5$		$\pm 0.8$		$\pm 1.5$	$^\circ\text{C}$
	$T_A = T_{\text{MIN}}$	$\pm 0.8$		$\pm 1.5$	$\pm 0.8$		$\pm 2.0$	$^\circ\text{C}$
Accuracy, LM35D (Note 7)	$T_A = +25^\circ\text{C}$				$\pm 0.6$	$\pm 1.5$		$^\circ\text{C}$
	$T_A = T_{\text{MAX}}$				$\pm 0.9$		$\pm 2.0$	$^\circ\text{C}$
	$T_A = T_{\text{MIN}}$				$\pm 0.9$		$\pm 2.0$	$^\circ\text{C}$
Nonlinearity (Note 8)	$T_{\text{MIN}} \leq T_A \leq T_{\text{MAX}}$	$\pm 0.3$		$\pm 0.5$	$\pm 0.2$		$\pm 0.5$	$^\circ\text{C}$
Sensor Gain (Average Slope)	$T_{\text{MIN}} \leq T_A \leq T_{\text{MAX}}$	$+ 10.0$	$+ 9.8,$ $+ 10.2$		$+ 10.0$		$+ 9.8,$ $+ 10.2$	mV/ $^\circ\text{C}$
Load Regulation (Note 3) $0 \leq I_L \leq 1 \text{ mA}$	$T_A = +25^\circ\text{C}$	$\pm 0.4$	$\pm 2.0$		$\pm 0.4$	$\pm 2.0$		mV/mA
	$T_{\text{MIN}} \leq T_A \leq T_{\text{MAX}}$	$\pm 0.5$		$\pm 5.0$	$\pm 0.5$		$\pm 5.0$	mV/mA
Line Regulation (Note 3)	$T_A = +25^\circ\text{C}$	$\pm 0.01$	$\pm 0.1$		$\pm 0.01$	$\pm 0.1$		mV/V
	$4\text{V} \leq V_S \leq 30\text{V}$	$\pm 0.02$		$\pm 0.2$	$\pm 0.02$		$\pm 0.2$	mV/V
Quiescent Current (Note 9)	$V_S = +5\text{V}, +25^\circ\text{C}$	56	80		56	80		$\mu\text{A}$
	$V_S = +5\text{V}$	<b>105</b>		<b>158</b>	<b>91</b>		<b>138</b>	$\mu\text{A}$
	$V_S = +30\text{V}, +25^\circ\text{C}$	56.2	82		56.2	82		$\mu\text{A}$
	$V_S = +30\text{V}$	<b>105.5</b>		<b>161</b>	<b>91.5</b>		<b>141</b>	$\mu\text{A}$
Change of Quiescent Current (Note 3)	$4\text{V} \leq V_S \leq 30\text{V}, +25^\circ\text{C}$	0.2	2.0		0.2	2.0		$\mu\text{A}$
	$4\text{V} \leq V_S \leq 30\text{V}$	<b>0.5</b>		<b>3.0</b>	<b>0.5</b>		<b>3.0</b>	$\mu\text{A}$
Temperature Coefficient of Quiescent Current		$+ 0.39$		$+ 0.7$	$+ 0.39$		$+ 0.7$	$\mu\text{A}/^\circ\text{C}$
Minimum Temperature for Rated Accuracy	In circuit of <i>Figure 1</i> , $I_L = 0$	$+ 1.5$		$+ 2.0$	$+ 1.5$		$+ 2.0$	$^\circ\text{C}$
Long Term Stability	$T_J = T_{\text{MAX}}$ , for 1000 hours	$\pm 0.08$			$\pm 0.08$			$^\circ\text{C}$

**Note 3:** Regulation is measured at constant junction temperature, using pulse testing with a low duty cycle. Changes in output due to heating effects can be computed by multiplying the internal dissipation by the thermal resistance.

**Note 4:** Tested Limits are guaranteed and 100% tested in production.

**Note 5:** Design Limits are guaranteed (but not 100% production tested) over the indicated temperature and supply voltage ranges. These limits are not used to calculate outgoing quality levels.

**Note 6:** Specifications in **boldface** apply over the full rated temperature range.

**Note 7:** Accuracy is defined as the error between the output voltage and  $10\text{mV}/^\circ\text{C}$  times the device's case temperature, at specified conditions of voltage, current, and temperature (expressed in  $^\circ\text{C}$ ).

**Note 8:** Nonlinearity is defined as the deviation of the output-voltage-versus-temperature curve from the best-fit straight line, over the device's rated temperature range.

**Note 9:** Quiescent current is defined in the circuit of *Figure 1*.

**Note 10:** Absolute Maximum Ratings indicate limits beyond which damage to the device may occur. DC and AC electrical specifications do not apply when operating the device beyond its rated operating conditions. See Note 1.

**Note 11:** Human body model, 100 pF discharged through a 1.5 k $\Omega$  resistor.

**Note 12:** See AN-450 "Surface Mounting Methods and Their Effect on Product Reliability" or the section titled "Surface Mount" found in a current National Semiconductor Linear Data Book for other methods of soldering surface mount devices.

# Typical Performance Characteristics

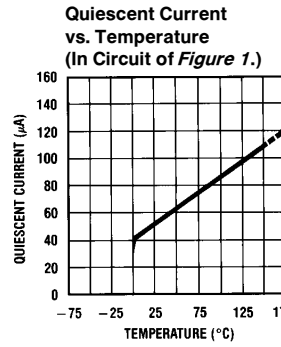
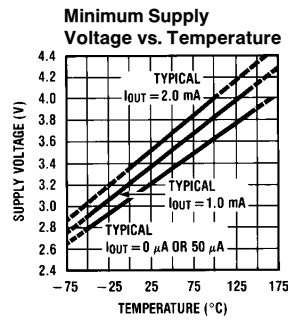
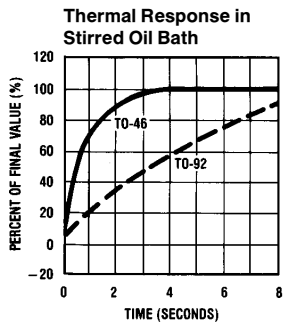
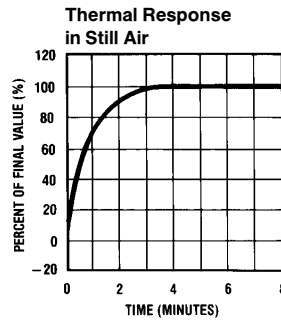
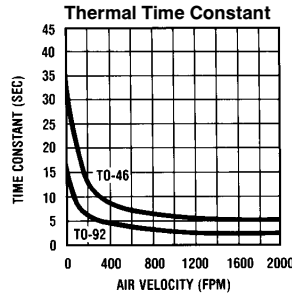
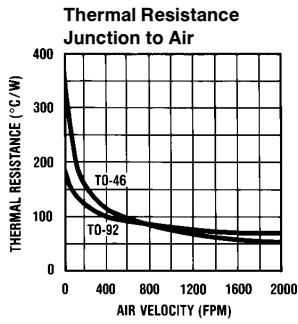

TL/H/5516-17

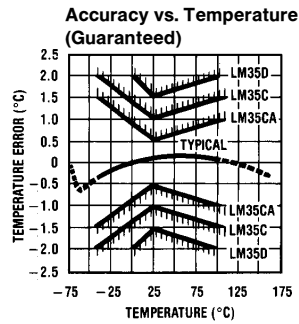
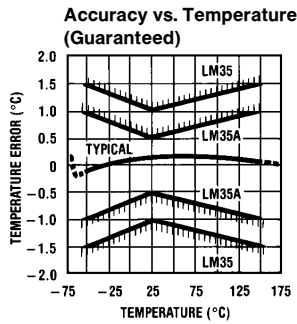
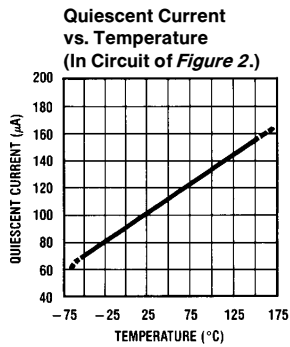

TL/H/5516-18

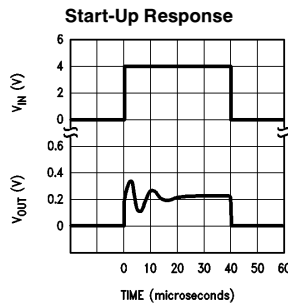
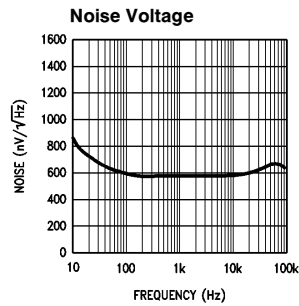

TL/H/5516-22

## Applications

The LM35 can be applied easily in the same way as other integrated-circuit temperature sensors. It can be glued or cemented to a surface and its temperature will be within about 0.01°C of the surface temperature.

This presumes that the ambient air temperature is almost the same as the surface temperature; if the air temperature were much higher or lower than the surface temperature, the actual temperature of the LM35 die would be at an intermediate temperature between the surface temperature and the air temperature. This is especially true for the TO-92 plastic package, where the copper leads are the principal thermal path to carry heat into the device, so its temperature might be closer to the air temperature than to the surface temperature.

To minimize this problem, be sure that the wiring to the LM35, as it leaves the device, is held at the same temperature as the surface of interest. The easiest way to do this is to cover up these wires with a bead of epoxy which will insure that the leads and wires are all at the same temperature as the surface, and that the LM35 die's temperature will not be affected by the air temperature.

The TO-46 metal package can also be soldered to a metal surface or pipe without damage. Of course, in that case the V— terminal of the circuit will be grounded to that metal. Alternatively, the LM35 can be mounted inside a sealed-end metal tube, and can then be dipped into a bath or screwed into a threaded hole in a tank. As with any IC, the LM35 and accompanying wiring and circuits must be kept insulated and dry, to avoid leakage and corrosion. This is especially true if the circuit may operate at cold temperatures where condensation can occur. Printed-circuit coatings and varnishes such as Humiseal and epoxy paints or dips are often used to insure that moisture cannot corrode the LM35 or its connections.

These devices are sometimes soldered to a small light-weight heat fin, to decrease the thermal time constant and speed up the response in slowly-moving air. On the other hand, a small thermal mass may be added to the sensor, to give the steadiest reading despite small deviations in the air temperature.

Temperature Rise of LM35 Due To Self-heating (Thermal Resistance)

	TO-46, no heat sink	TO-46, small heat fin*	TO-92, no heat sink	TO-92, small heat fin**	SO-8 no heat sink	SO-8 small heat fin**	TO-202 no heat sink	TO-202 *** small heat fin
Still air	400°C/W	100°C/W	180°C/W	140°C/W	220°C/W	110°C/W	85°C/W	60°C/W
Moving air	100°C/W	40°C/W	90°C/W	70°C/W	105°C/W	90°C/W	25°C/W	40°C/W
Still oil	100°C/W	40°C/W	90°C/W	70°C/W				
Stirred oil	50°C/W	30°C/W	45°C/W	40°C/W				
(Clamped to metal, Infinite heat sink)	(24°C/W)				(55°C/W)		(23°C/W)	

\* Wakefield type 201, or 1" disc of 0.020" sheet brass, soldered to case, or similar.

\*\* TO-92 and SO-8 packages glued and leads soldered to 1" square of 1/16" printed circuit board with 2 oz. foil or similar.

## Typical Applications (Continued)

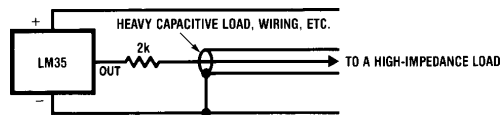

TL/H/5516-19

FIGURE 3. LM35 with Decoupling from Capacitive Load

### CAPACITIVE LOADS

Like most micropower circuits, the LM35 has a limited ability to drive heavy capacitive loads. The LM35 by itself is able to drive 50 pF without special precautions. If heavier loads are anticipated, it is easy to isolate or decouple the load with a resistor; see Figure 3. Or you can improve the tolerance of capacitance with a series R-C damper from output to ground; see Figure 4.

When the LM35 is applied with a 200Ω load resistor as shown in Figure 5, 6, or 8, it is relatively immune to wiring

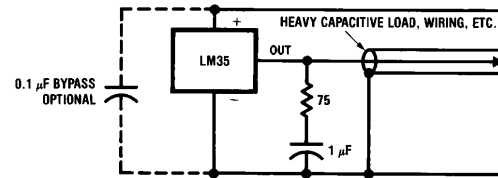

TL/H/5516-20

FIGURE 4. LM35 with R-C Damper

capacitance because the capacitance forms a bypass from ground to input, not on the output. However, as with any linear circuit connected to wires in a hostile environment, its performance can be affected adversely by intense electromagnetic sources such as relays, radio transmitters, motors with arcing brushes, SCR transients, etc. as its wiring can act as a receiving antenna and its internal junctions can act as rectifiers. For best results in such cases, a bypass capacitor from  $V_{IN}$  to ground and a series R-C damper such as 75Ω in series with 0.2 or 1 μF from output to ground are often useful. These are shown in Figures 13, 14, and 16.

## Typical Applications (Continued)

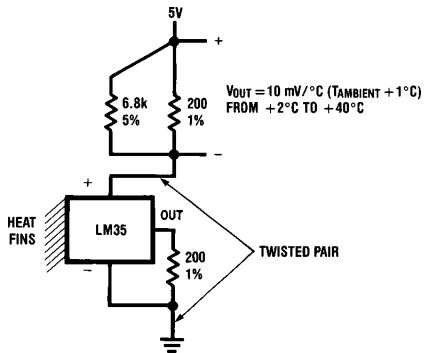

TL/H/5516-5

**FIGURE 5. Two-Wire Remote Temperature Sensor (Grounded Sensor)**

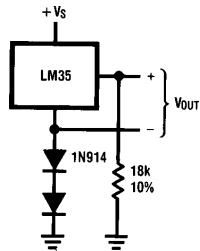

TL/H/5516-7

**FIGURE 7. Temperature Sensor, Single Supply,  $-55^{\circ}$  to  $+150^{\circ}\text{C}$**

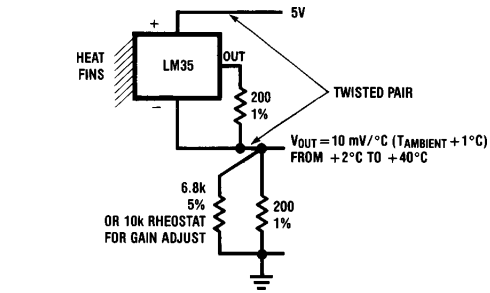

TL/H/5516-6

**FIGURE 6. Two-Wire Remote Temperature Sensor (Output Referred to Ground)**

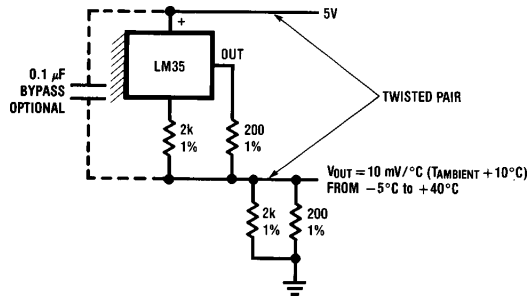

TL/H/5516-8

**FIGURE 8. Two-Wire Remote Temperature Sensor (Output Referred to Ground)**

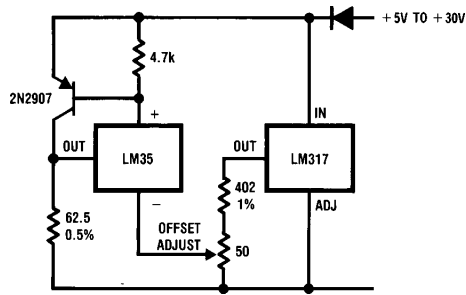

TL/H/5516-9

**FIGURE 9. 4-To-20 mA Current Source ( $0^{\circ}\text{C}$  to  $+100^{\circ}\text{C}$ )**

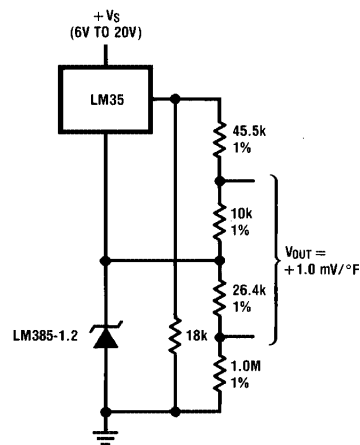

TL/H/5516-10

**FIGURE 10. Fahrenheit Thermometer**

**Typical Applications** (Continued)

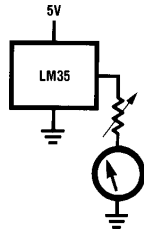

TL/H/5516-11

**FIGURE 11. Centigrade Thermometer (Analog Meter)**

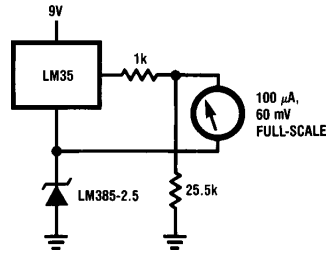

TL/H/5516-12

**FIGURE 12. Expanded Scale Thermometer (50° to 80° Fahrenheit, for Example Shown)**

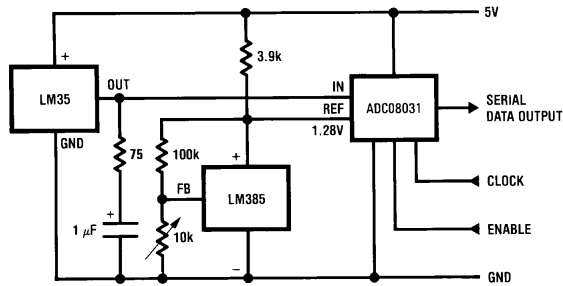

TL/H/5516-13

**FIGURE 13. Temperature To Digital Converter (Serial Output) (+ 128°C Full Scale)**

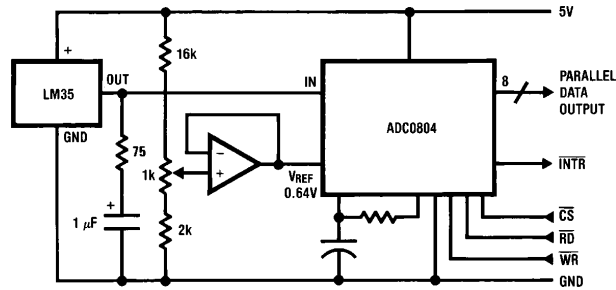

TL/H/5516-14

**FIGURE 14. Temperature To Digital Converter (Parallel TRI-STATE® Outputs for Standard Data Bus to  $\mu$ P Interface) (128°C Full Scale)**





## Block Diagram

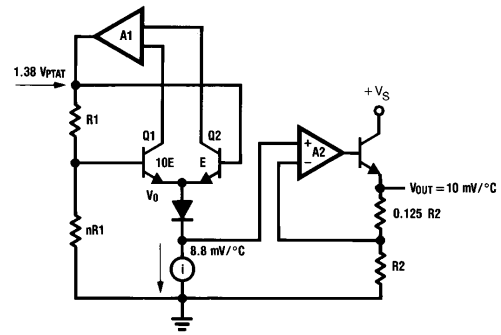

TL/H/5516-23

**Physical Dimensions** inches (millimeters)

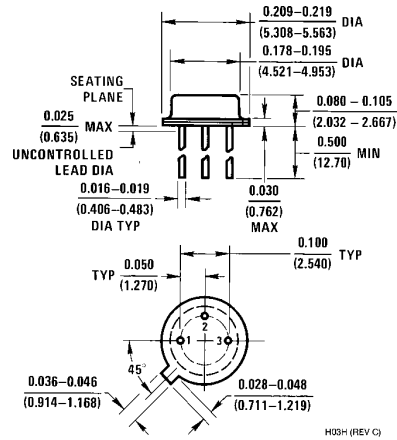

**TO-46 Metal Can Package (H)**  
**Order Number LM35H, LM35AH, LM35CH,**  
**LM35CAH, or LM35DH**  
**NS Package Number H03H**

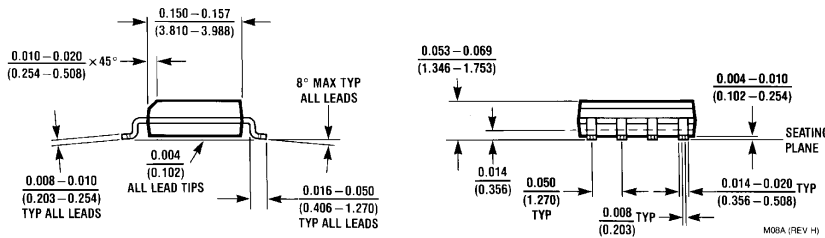
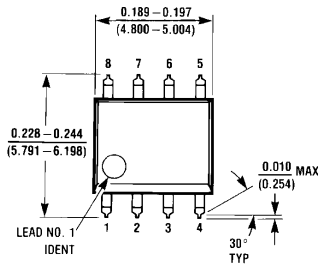

**SO-8 Molded Small Outline Package (M)**  
**Order Number LM35DM**  
**NS Package Number M08A**

**Physical Dimensions** inches (millimeters) (Continued)

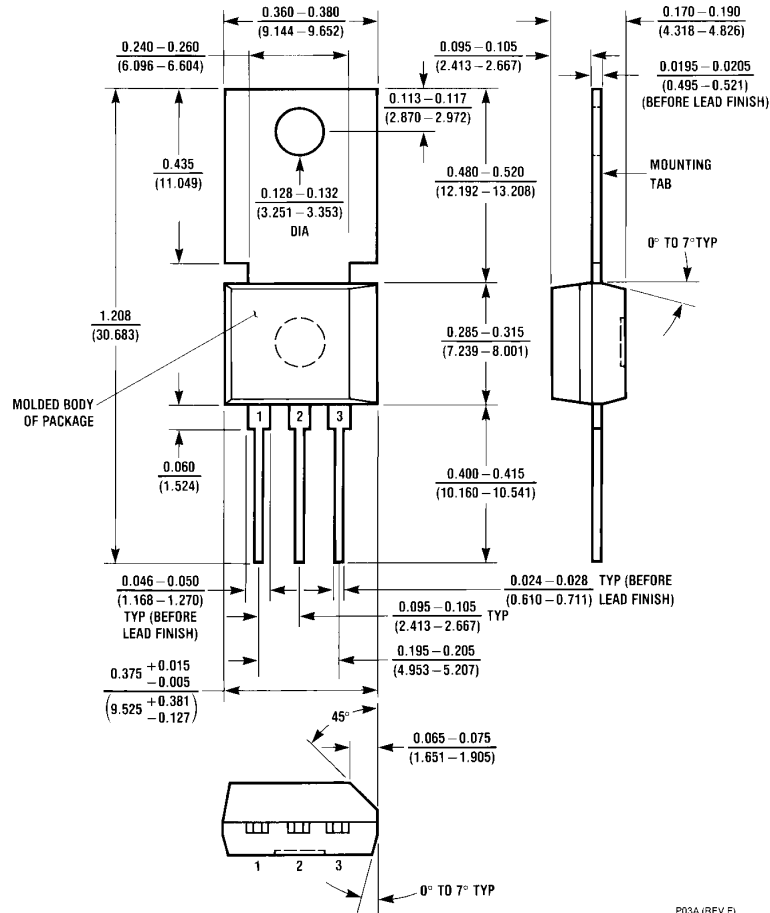

P03A (REV F)

**Power Package TO-202 (P)**  
**Order Number LM35DP**  
**NS Package Number P03A**

**LM35/LM35A/LM35C/LM35CA/LM35D  
Precision Centigrade Temperature Sensors**

**Physical Dimensions** inches (millimeters) (Continued)

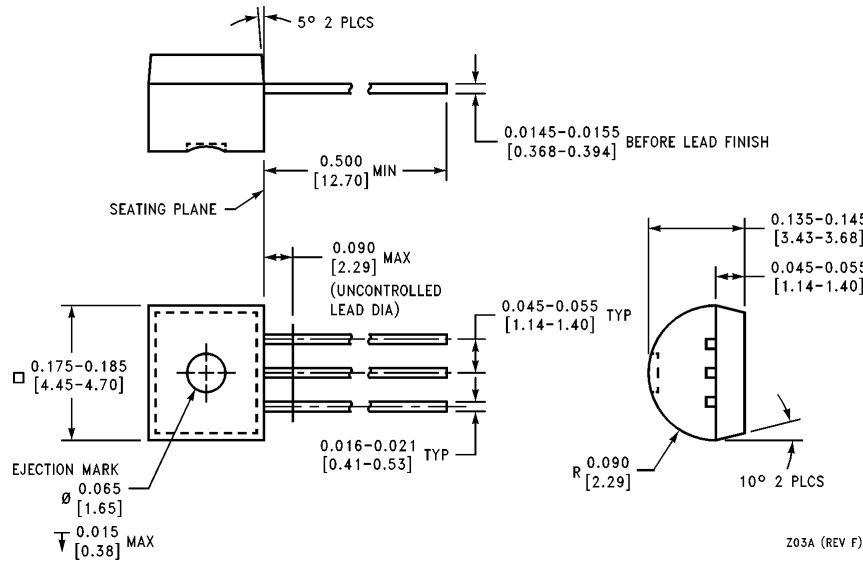

**TO-92 Plastic Package (Z)  
Order Number LM35CZ, LM35CAZ or LM35DZ  
NS Package Number Z03A**

Z03A (REV F)

**LIFE SUPPORT POLICY**

NATIONAL'S PRODUCTS ARE NOT AUTHORIZED FOR USE AS CRITICAL COMPONENTS IN LIFE SUPPORT DEVICES OR SYSTEMS WITHOUT THE EXPRESS WRITTEN APPROVAL OF THE PRESIDENT OF NATIONAL SEMICONDUCTOR CORPORATION. As used herein:

1. Life support devices or systems are devices or systems which, (a) are intended for surgical implant into the body, or (b) support or sustain life, and whose failure to perform, when properly used in accordance with instructions for use provided in the labeling, can be reasonably expected to result in a significant injury to the user.
2. A critical component is any component of a life support device or system whose failure to perform can be reasonably expected to cause the failure of the life support device or system, or to affect its safety or effectiveness.



**National Semiconductor Corporation**  
2900 Semiconductor Drive  
P.O. Box 58090  
Santa Clara, CA 95052-8090  
Tel: 1(800) 272-9959  
TWX: (910) 339-9240

**National Semiconductor GmbH**  
Livny-Gargan-Str. 10  
D-82256 Fürstenfeldbruck  
Germany  
Tel: (81-41) 35-0  
Telex: 527849  
Fax: (81-41) 35-1

**National Semiconductor Japan Ltd.**  
Sumitomo Chemical  
Engineering Center  
Bldg. 7F  
1-7-1, Nakase, Mihama-Ku  
Chiba-City,  
Ciba Prefecture 261  
Tel: (043) 299-2300  
Fax: (043) 299-2500

**National Semiconductor Hong Kong Ltd.**  
13th Floor, Straight Block,  
Ocean Centre, 5 Canton Rd.  
Tsimshatsui, Kowloon  
Hong Kong  
Tel: (852) 2737-1600  
Fax: (852) 2736-9960

**National Semicondutores Do Brazil Ltda.**  
Rue Deputado Lacorda Franco  
120-3A  
Sao Paulo-SP  
Brazil 05418-000  
Tel: (55-11) 212-5066  
Telex: 391-1131931 NSBR BR  
Fax: (55-11) 212-1181

**National Semiconductor (Australia) Pty. Ltd.**  
Building 16  
Business Park Drive  
Monash Business Park  
Nottingham, Melbourne  
Victoria 3168 Australia  
Tel: (3) 558-9999  
Fax: (3) 558-9998

National does not assume any responsibility for use of any circuitry described, no circuit patent licenses are implied and National reserves the right at any time without notice to change said circuitry and specifications.

This datasheet has been download from:

[www.datasheetcatalog.com](http://www.datasheetcatalog.com)

Datasheets for electronics components.